

*Back and Side Wired Momentary Contact 15 AMP 120/277V AC*

DESCRIPTION	CAT. NO.	COLOR*
Single Pole, Double Throw, Center OFF	5657-2	I, W, A, GY, E <small>Basic Cat. No. Denotes Mahogany</small>

*Back and Side Wired Maintained Contact 15 AMP 120/277V AC*

DESCRIPTION	CAT. NO.	COLOR*
Single Pole, Double Throw, Center OFF	5685-2	I, W, A, GY, E <small>Basic Cat. No. Denotes Mahogany</small>
Double Pole, Double Throw, Center OFF	5686-2	I, W, A (No Mahogany)

All devices are UL Listed and CSA Certified.



5686-2W in 80301-W



5686-2I in 80301-I

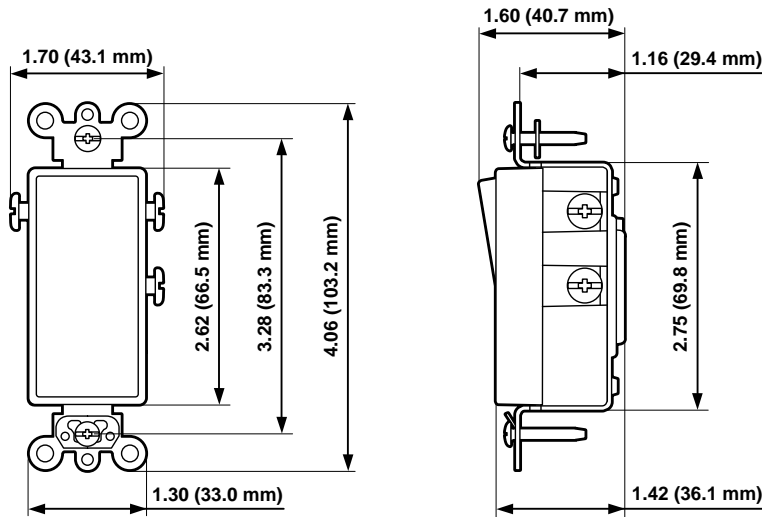

**SINGLE POLE**  
Cat. Nos. 5657 and 5685

THESE DIMENSIONS APPLY TO ALL SWITCHES ON THIS PAGE

**SPECIFICATIONS & FEATURES**

- Full rated current capacity with tungsten, fluorescent or resistive loads. Motor capacity is 80% of switch rating
- Wrap-around heavy-gauge strap with locking tabs for added strength
- Back and side-wiring terminals accept both solid and stranded wire to ease installation

**TESTING & CODE COMPLIANCE**

- UL Listed (File #E-7458)
- CSA Certified (File #LR-3413)
- NOM Certified (#057)
- Meets requirements of latest Federal Specification WS-896
- Backed by a Limited 10-Year Warranty

**\*COLOR**

Colors available as listed. For other color selections, add suffix to catalog numbers as follows: Ivory (-I), White (-W), Almond (-A), Gray (-GY), Black (-E).

**HORSE POWER**

15A  
1/2 @ 120V  
2 @ 240V

**MATERIAL CHARACTERISTICS**

Environmental: Flammability UL-94, V2 Rating  
Operating Temperature: -40°C to 120°C

For more information regarding matching wallplates, colors, materials, single and multi-gang, refer to Wallplates, section G.



**10 YEAR LIMITED WARRANTY**

## Commercial Grade, Back & Side Wired

Commercial Grade Maintained & Momentary Contact AC Switches

**A 22**

ELECTRICAL			
DIELECTRIC VOLTAGE	OVERLOAD UL 20 TEST	TEMP. RISE	ENDURANCE
Withstands 1500V for 1min	100 cycles of overload at 4.8 times rated current	30°C max at full rated current	UL 20/Fed Spec 50,000 cycles min., tungsten filament lamp load (Fed. Spec.) WS896E, SP, DP, 3-way, 4-way, Pilot Light, Illum., Key Lock

ENVIRONMENTAL	
FLAMMABILITY	OPERATING TEMP.
Rated V-2 per UL 94	-40°C to 65°C

MECHANICAL			
TERMINAL I.D.	TERMINAL ACCOMM.	PRODUCT I.D.	TORQUE RANGE
Brass-Hot, Black-Hot, White-Neutral, Green-Grounding	#14-#10 AWG back wired #14-#12 AWG side wired	Ratings are permanently stamped on device strap	12-14 inch pounds

STANDARDS & CERTIFICATION					
NEMA WD1 & WD6	ANSI C-73	UL 20	UL Fed Spec WS896E	CUL per CSA C22.2 No.111	NOM
✓	✓	#E7458	#E7458	#E63969	#057

**PLUS DECORA**



AC HORSEPOWER RATINGS
<b>15 AMP</b>
1/2 @ 120V
2 @ 240V
<b>12 AMP MAX</b>

### Momentary Contact

TOGGLE COLOR	SINGLE-POLE DOUBLE-THROW CENTER OFF
<b>15 AMP</b>	
Brown	5657-2
Ivory	5657-2I
White	5657-2W
Almond	5657-2A
Gray	5657-2GY

### Maintained Contact

TOGGLE COLOR	SINGLE-POLE DOUBLE-THROW CENTER OFF	DOUBLE-POLE DOUBLE-THROW CENTER OFF
<b>15 AMP</b>		
Brown	5685-2	5686-2
Ivory	5685-2I	5686-2I
White	5685-2W	5686-2W
Almond	5685-2A	5686-2A
Gray	5685-2GY	-

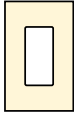
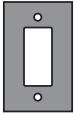
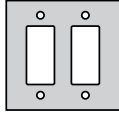
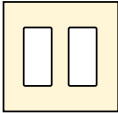
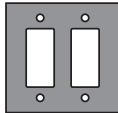
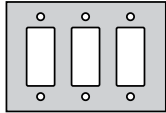
SCREWLESS SNAP-ON WALLPLATES	NYLON WALLPLATES	302 STAINLESS STEEL WALLPLATES
 80301-I	 80401-GY	 84409-40
 80309-I	 80409-GY	 84411-40

FOR ADDITIONAL WALLPLATE OPTIONS SEE SECTION Q

