

REVISIONS			
REV.	DESCRIPTION	DATE	APPROVED

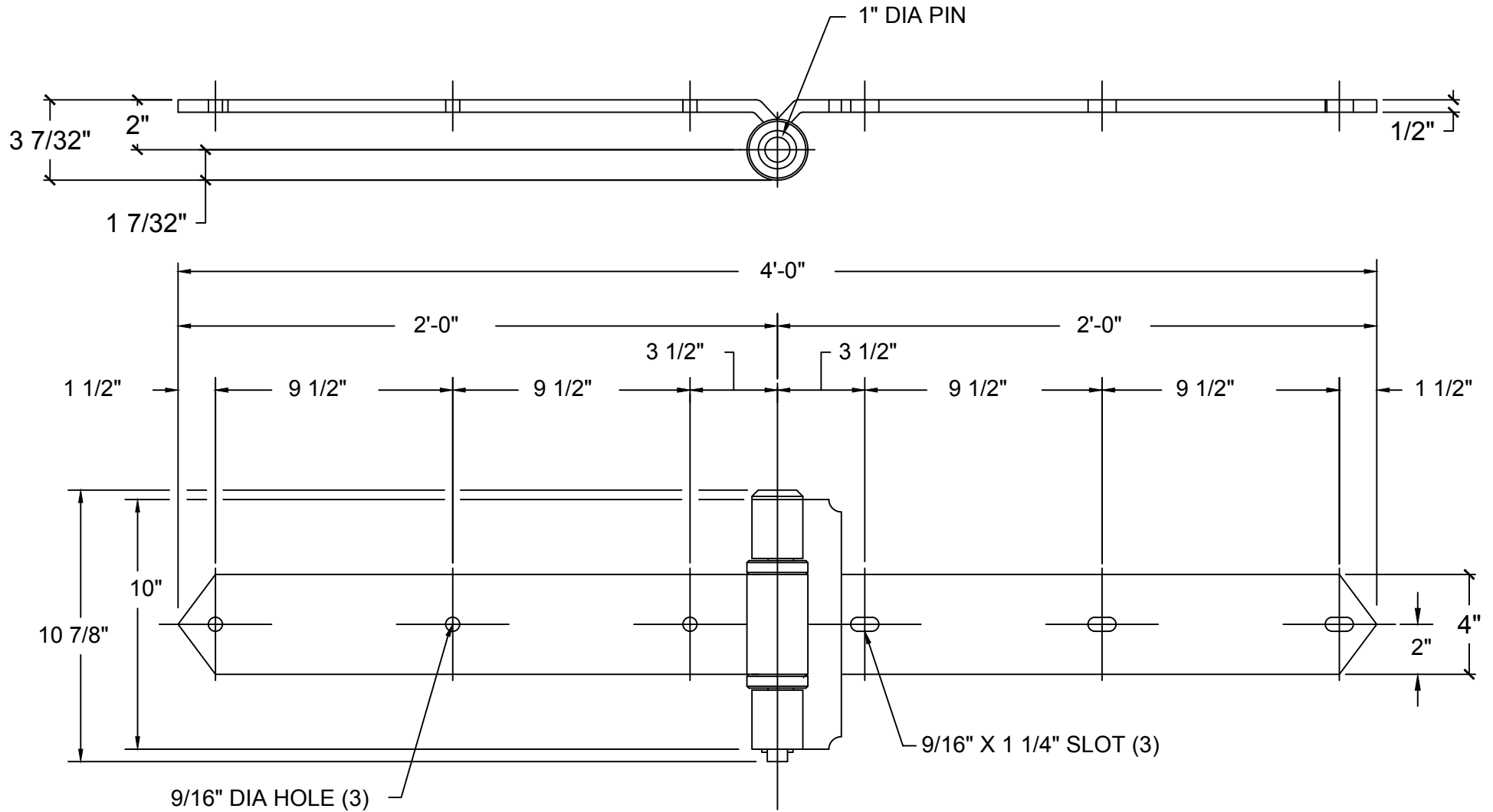

DWG #934-P328
 DESCRIP: K Hinge, Ball Bearing 1/2" x 4"
 DRAWN:BCM
 SHEET # 1
 FILE:z:\engineering\hardware\hinges\934\934-p328

THE INFORMATION CONTAINED IN THIS DRAWING IS THE SOLE PROPERTY OF CROWN INDUSTRIAL. ANY REPRODUCTION IN PART OR AS A WHOLE WITHOUT WRITTEN PERMISSION OF CROWN INDUSTRIAL IS PROHIBITED.



CROWN INDUSTRIAL
 So. San Francisco, Ca
 (650) 952-5150
 www.crown-industrial.com